

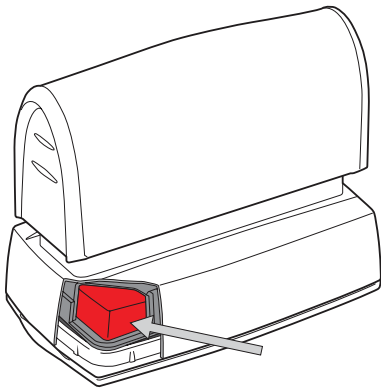

Premium Pre-Inked Stamps



The 2000 Plus HD stamps contain a large built-in ink reservoir resulting in up to four times the number of impressions than a self-inking stamp (which equates to ~20,000 impressions) thus practically eliminating the need to re-ink for the life of the stamp.



The most popular sizes have an attached lid so users will never lose this cap, and it significantly reduces the risk of getting ink on their hands.

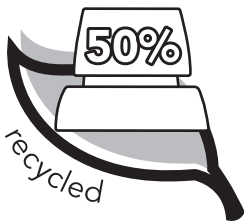

2000 Plus HD Series contains 50% post-consumer recycled material.

Certified "Document Proof" ink available in 7 colors – Black, Red, Blue, Green, Violet, Gold and Orange.



also available in gold and orange

HD SERIES



HD 12	
impression area	$5/16" \times 2 1/2"$
number of lines	2
packaging	
available ink colors	

with attached flip lid



SIGNATURE _____
 $5/16" \times 2 1/2"$

HD 20	
impression area	$9/16" \times 1 1/2"$
number of lines	4
packaging	
available ink colors	

with attached flip lid



PAUL A. JACOBS
 NINTH AVENUE 247
 DENVER, CO 75060
 TEL: 555 290 410
 $9/16" \times 1 1/2"$

HD 30	
impression area	$1 1/16" \times 2"$
number of lines	5
packaging	
available ink colors	

with attached flip lid



PAY TO THE ORDER OF
 Yorkville Bank and Trust Co.
 North Philadelphia Office
 Dr. Peter A. Jacobs
 375493603
 $1 1/16" \times 2"$

HD 35	
impression area	$1 3/16" \times 2"$
number of lines	7
packaging	
available ink colors	

with attached flip lid



WAYNE INDUSTRIES
 390 Gotham Lane 99
 Gotham City, GC 10086
 tel: 555 490 310
 fax 555 490 311
 e-mail: wayne@industries.net
 $1 3/16" \times 2"$

HD 40	
impression area	$7/8" \times 2 5/16"$
number of lines	6
packaging	
available ink colors	

with attached flip lid





REDWOOD
 market garden
 Seaside Avenue 347/348
 Hill Valley, CA 90104
 tel: 555 - 490 7102
 fax 555 - 490 7102
 $7/8" \times 2 5/16"$

HD 45	
impression area	$1 3/16" \times 3 3/16"$
number of lines	6
packaging	
available ink colors	

with attached flip lid



ATTENTION: OFFICE PRODUCTS BUYERS
SEPTEMBER SPECIALS
ENCLOSED
 $1" \times 3 3/16"$

HD 50	
impression area	1 3/16" x 2 3/4"
number of lines	7
packaging	 
available ink colors	

with attached flip lid



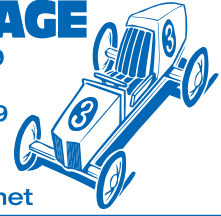

BOB'S GARAGE

34 Glendale Ave. 99
 Phoenix, AZ 85063
 mobile: 555 230 219
 tel: 555 240 227
 fax 555 240 228
 e-mail: bob@garage.net



1 3/16" x 2 3/4"

HD 55	
impression area	1 9/16" x 2 1/2"
number of lines	9
packaging	 
available ink colors	



with attached flip lid



Fruit Market

89 North-East Highway 82
 Phoenix, AZ 85063
 mobile: 555 290 311
 tel: 555 290 310
 fax 555 290 311
 e-mail: fresh@fruit.net

1 9/16" x 2 1/2"

HD 60	
impression area	1 1/2" x 3"
number of lines	8
packaging	 
available ink colors	



with attached flip lid



FLASH W. GORDON

5160 East Highway 99
 Phoenix, AZ 85063
 mobile: 555 290 3111
 tel: 555 290 3101
 fax 555 290 3111
 e-mail: flash@w.gordon.com
 www.flashwgordon.com



1 1/2" x 3"

HD R17	
impression area	1 1/16" dia
number of lines	2
packaging	 
available ink colors	

with attached flip lid



1 1/16" dia.









HD R40	
impression area	1 5/8" dia
number of lines	7
packaging	 
available ink colors	

with attached flip lid











1 5/8" dia.

HD SERIES

HD R50	
impression area	2" dia
number of lines	2
packaging	 
available ink colors	     











2" dia.

HD 110	
impression area	1 7/8" x 3 7/8"
number of lines	10
packaging	 
available ink colors	     







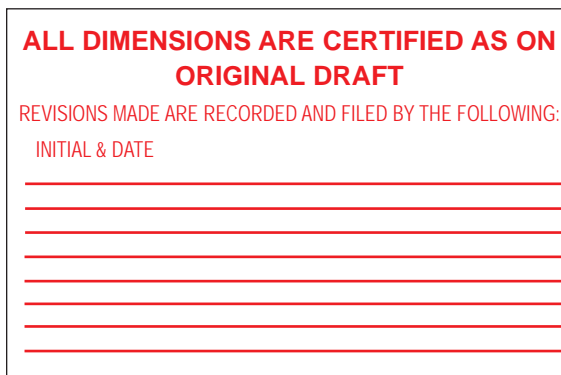

1 7/8" x 3 7/8"

HD 112	
impression area	1 15/16" x 2 15/16"
number of lines	10
packaging	 
available ink colors	     







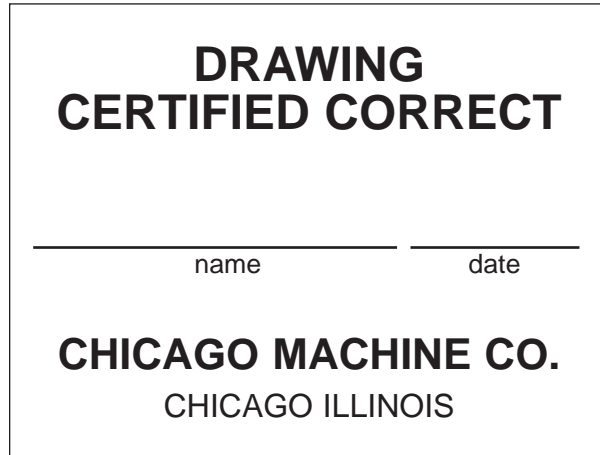

1 15/16" x 2 15/16"

HD 115	
impression area	2 3/8" x 3 1/8"
number of lines	12
packaging	 
available ink colors	   



2 3/8" x 3 1/8"

HD 120	
impression area	2 3/4" x 3 3/4"
number of lines	14
packaging	 
available ink colors	   



2 3/4" x 3 3/4"

HD SERIES



HD 130	
impression area	3 1/2" x 4 1/2"
number of lines	18
packaging	
available ink colors	



3 1/2" x 4 1/2"

HD 20 POCKET	
impression area	9/16" x 1 1/2"
number of lines	4
packaging	
available ink colors	



PAUL A. JACOBS
 NINTH AVENUE 247
 DENVER, CO 75060
 TEL: 555 290 410

9/16" x 1 1/2"

HD 30 POCKET	
impression area	1 1/16" x 2"
number of lines	5
packaging	
available ink colors	



PAY TO THE ORDER OF
 Yorkville Bank and Trust Co.
 North Philadelphia Office
 Dr. Peter A. Jacobs
 375493603

1 1/16" x 2"

HD 40 POCKET	
impression area	7/8" x 2 5/16"
number of lines	6
packaging	
available ink colors	



REDWOOD
 market garden
 Seaside Avenue 347/348
 Hill Valley, CA 90104
 tel: 555 - 490 7102
 fax 555 - 490 7102

7/8" x 2 5/16"